



# 中山市川狼五金制品厂

ZHONG SHAN CHUAN LANG LIGHTING CO., LTD

型号: 50W 模组玻璃透镜款 - 300W

外观图



线条图

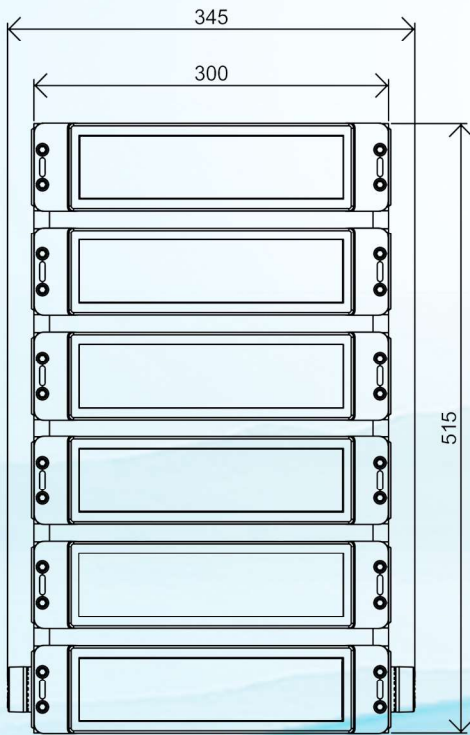

主视图

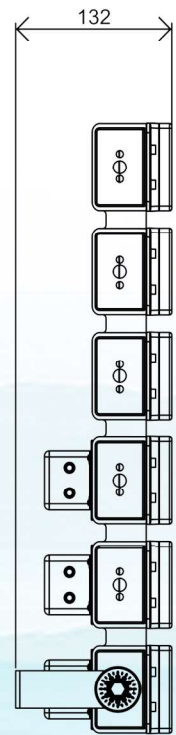

左视图

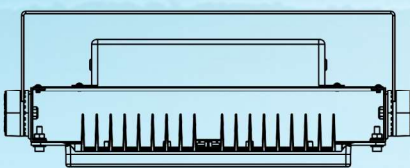

俯视图



透视图

灯体尺寸: L345\*W515\*H132

# 铝基板-反光纸

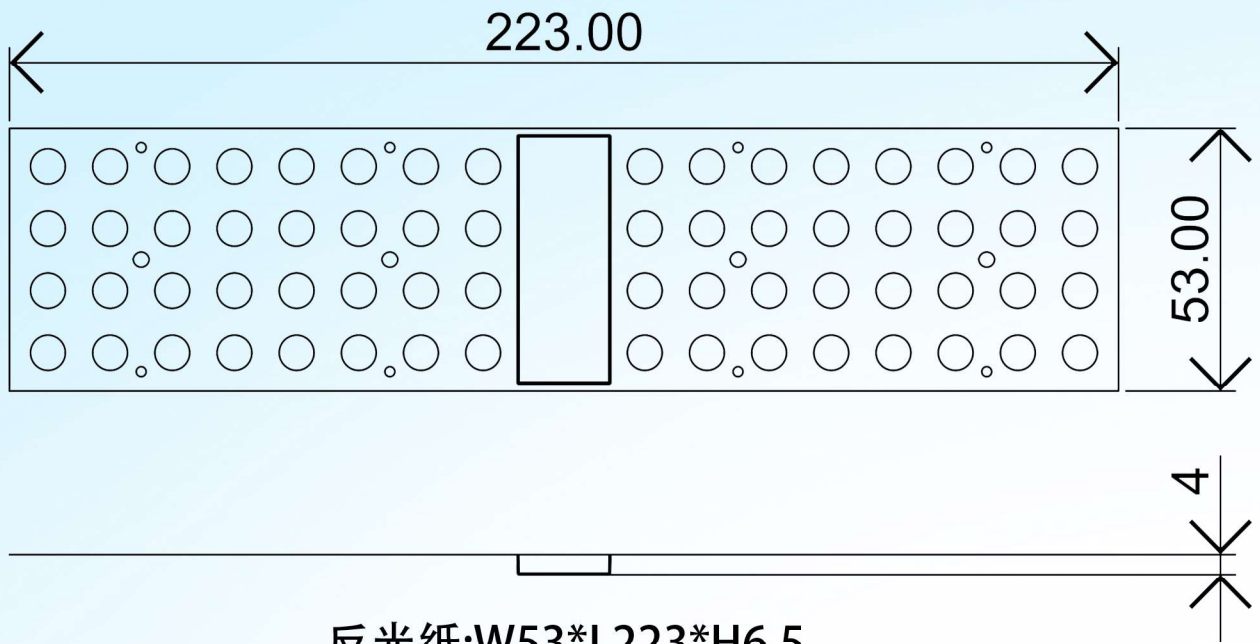

反光纸:W53\*L223\*H6.5

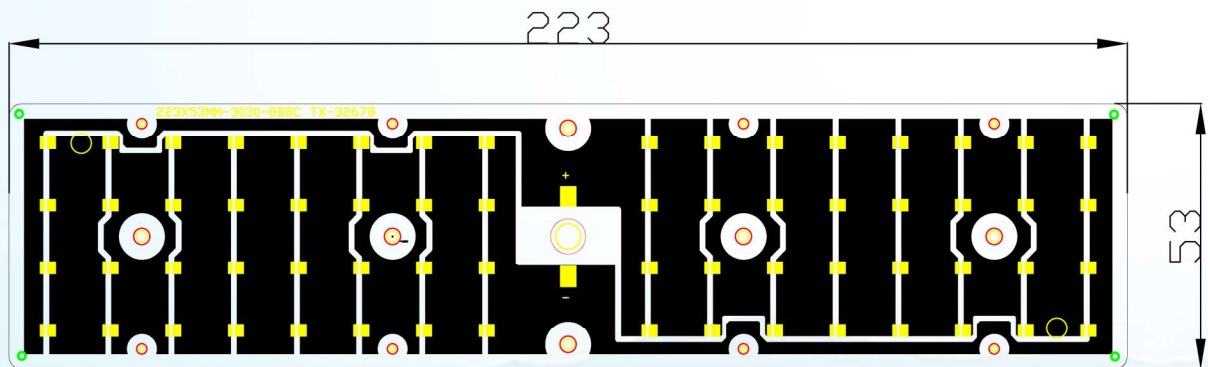

铝基板: W53\*L223\*1.0 8B8C 3030

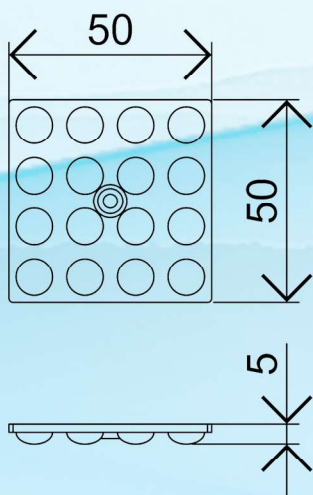

16合一透镜: 90度

# 尺寸孔位

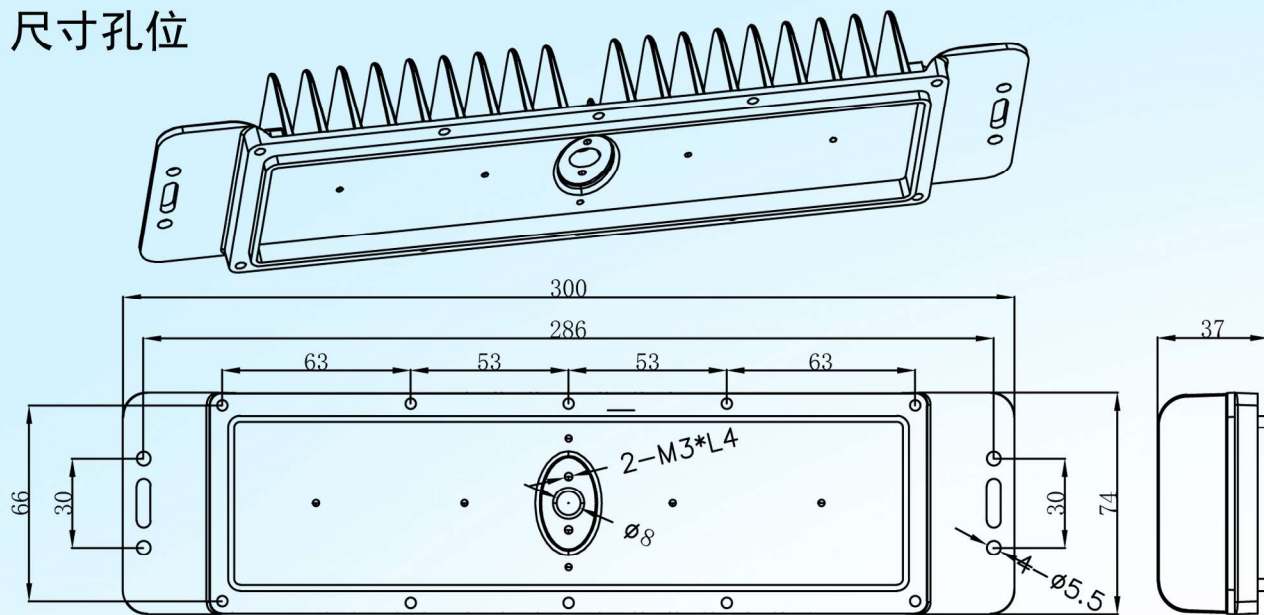

压铸铝灯体

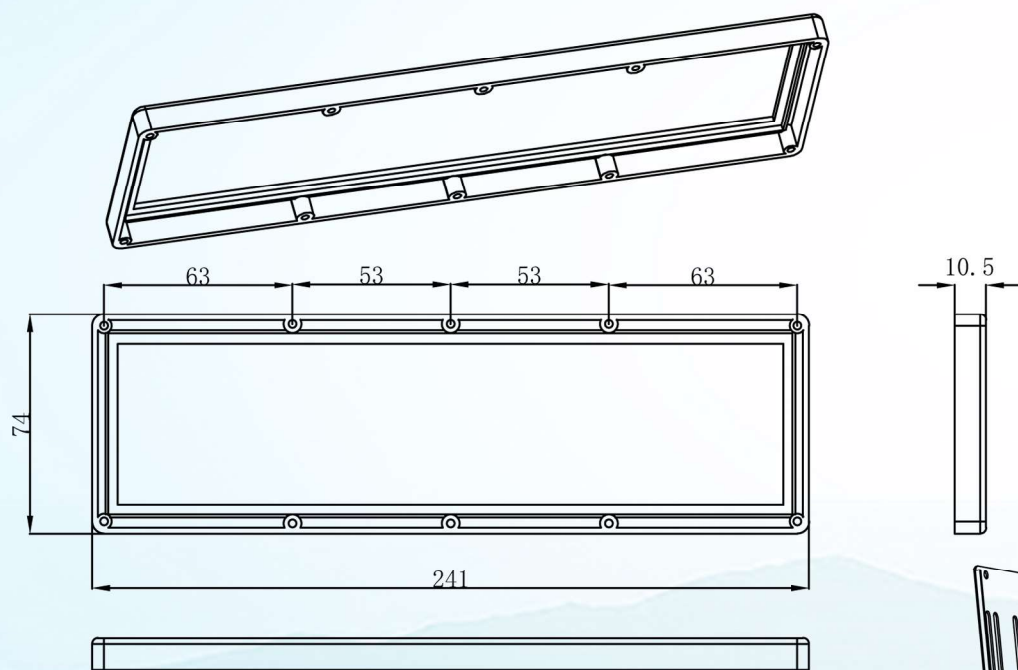

压铸铝面框

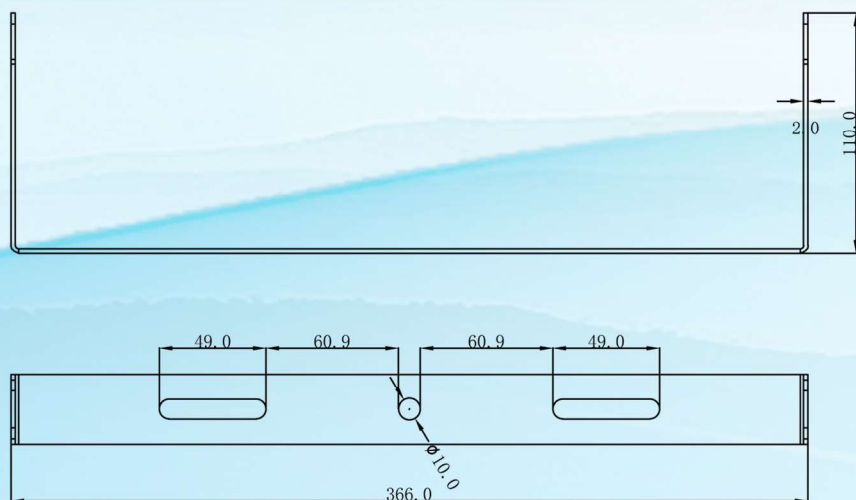

支架孔位

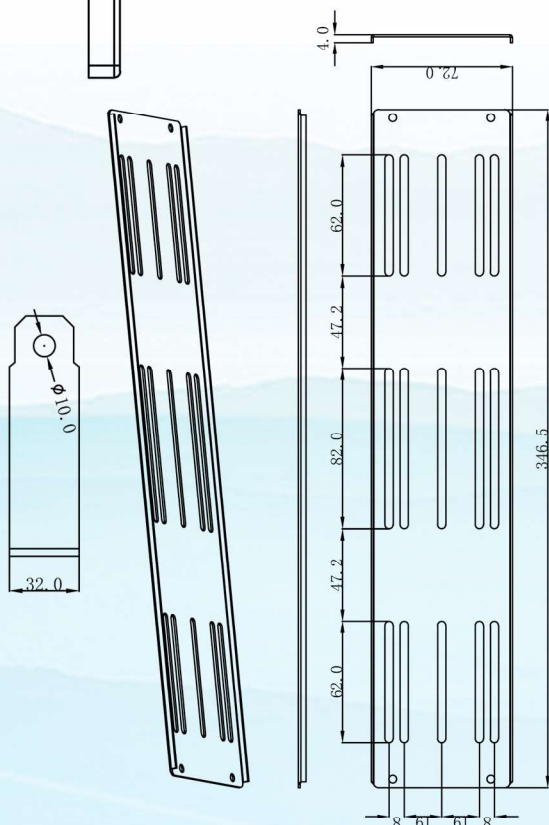

电源板孔位

# 爆炸图

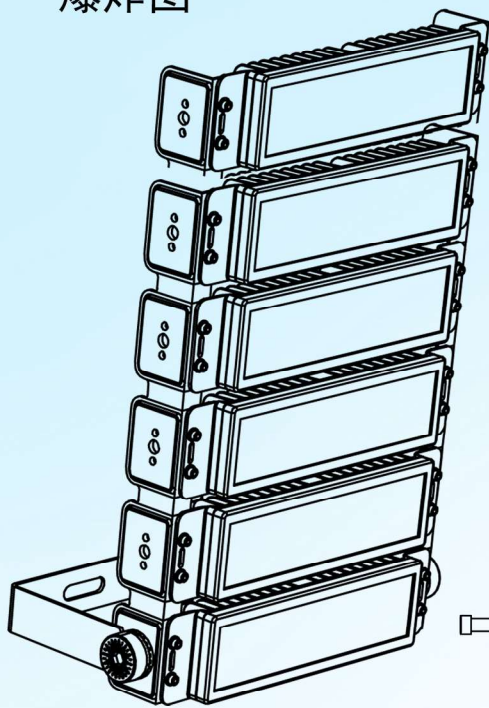

支架



驱动



电源板



M3螺丝

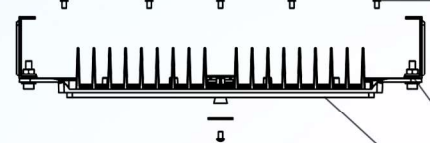

内六角螺丝



齿轮



折弯耳朵



散热器



铝基板



反光纸



透镜



透镜



玻璃



面框

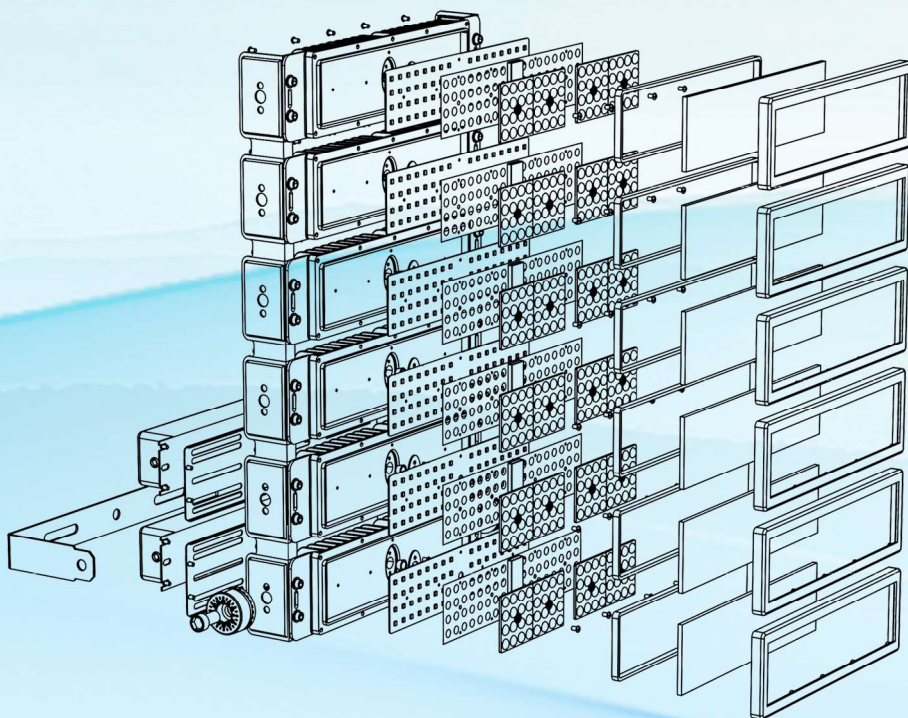

## 包装尺寸

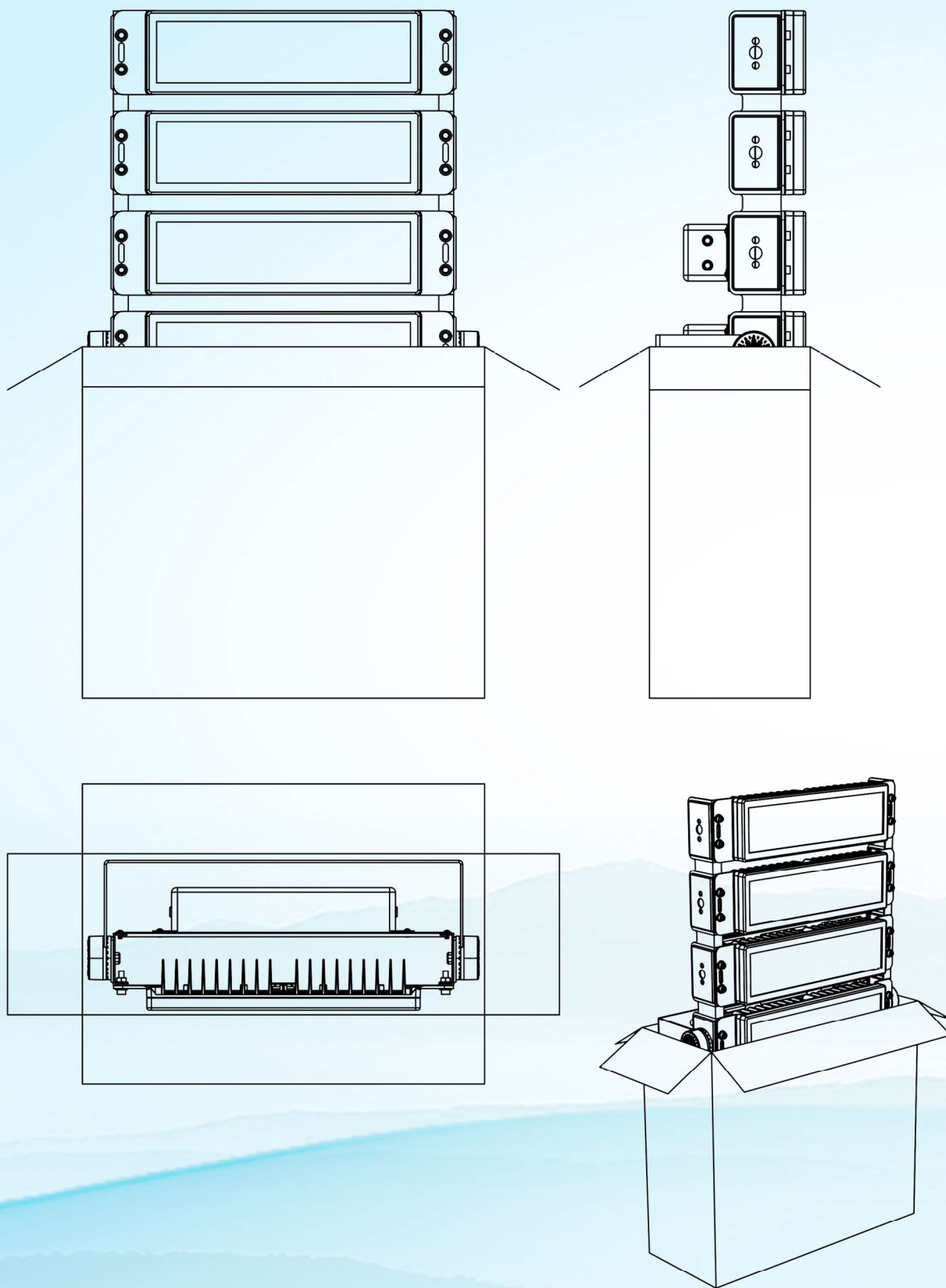

外箱尺寸：365mm\*500mm\*150mm